

Data Sheet



Article number: 20880M1615STK

Description: E+G
Oil drain valve GN 880-M16x1.5-ST-K

Measures

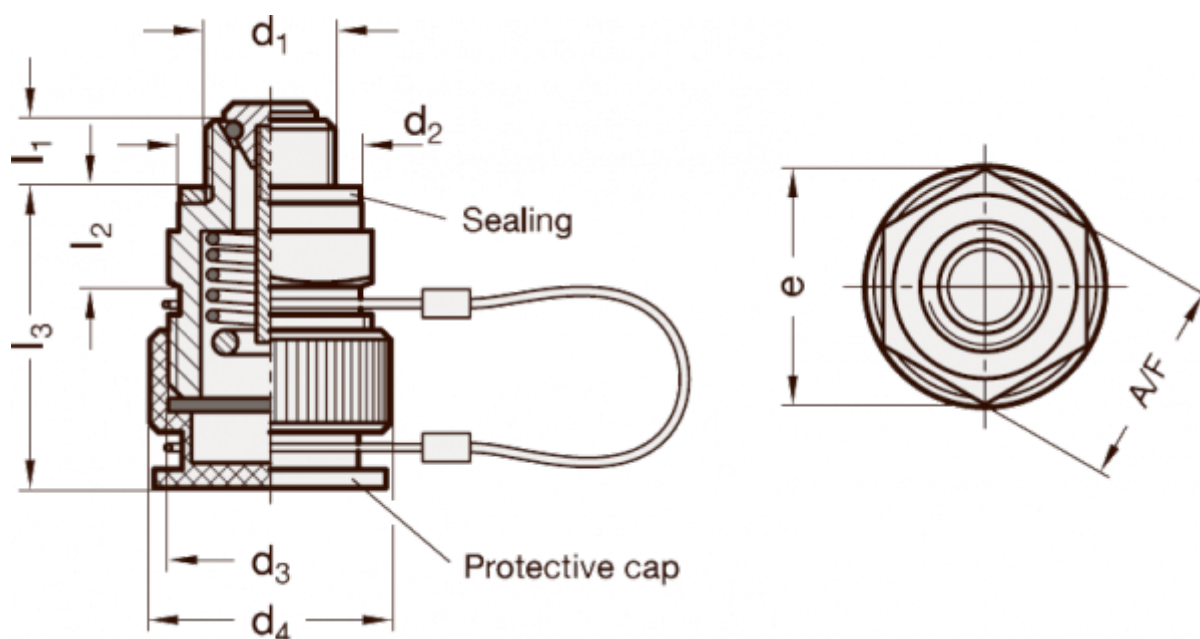

A/F	= 22
d2	= 22
d4	= 26
e	= 25.4
L1	= 7.5
L2	= 10.5
L3	= 31
Thread d1	= M16x1.5

Thread d3 = M22x1.5